

SCORPION

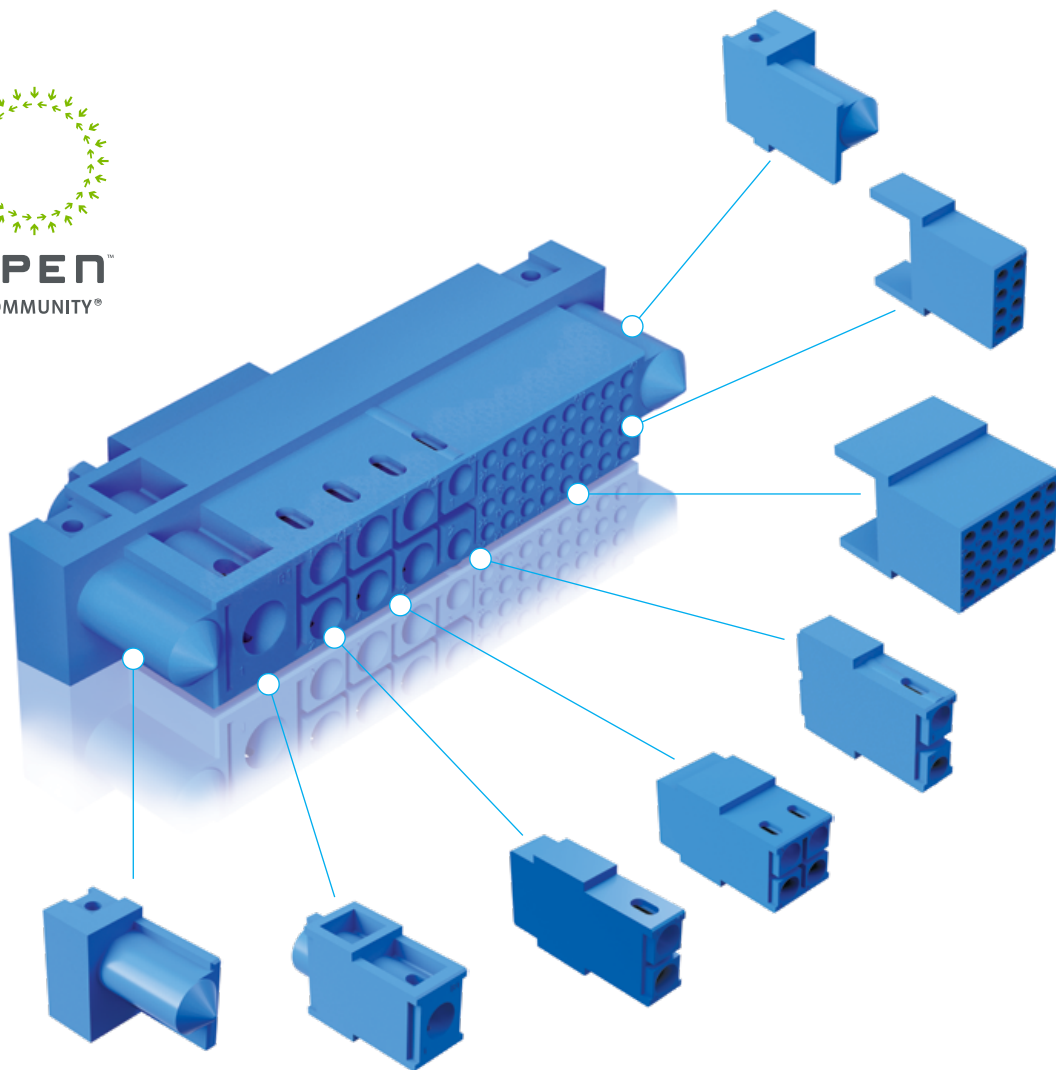

MODULAR POWER, SIGNAL CONNECTORS

- The most versatile modular power/signal connector on the planet
- Rated up to 100 amperes per contact plus ability to add signal contacts and a variety of accessories
- Venting options for improved air cooling
- Blank modules for greater creepage and clearance for higher voltage needs
- Unique locking systems for blind mating, float mount and cable connector options



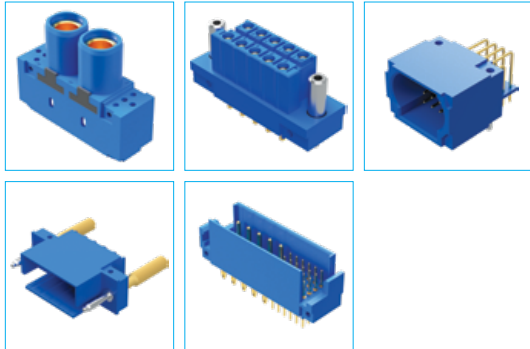
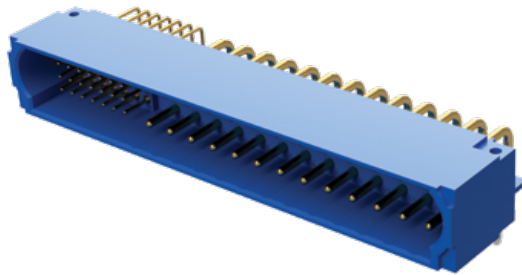

Scorpion brings a unique approach to modular connector design that is only available from Positronic. **Scorpion** provides the flexibility to configure the connector to meet your specifications. The difference is how Positronic builds the final connector, using our innovative tooling and injection molding process. The result is a **Scorpion** with solid body and machined contacts, ready to perform.

Trust the **Scorpion** to deliver *The Science of Certainty*

TECH SPECS

GENERAL

| | |
|--------------------|--|
| Part Number Prefix | SP |
| Performance Level | Industrial Mil/aero |
| Qualifications | UL #E49351* ¹ * ¹ Partial UL certification only. Contact Technical Sales for specific connector qualifications and for UL status of Hyperboloid contacts. |

MATERIAL

| | |
|---------------------|--|
| Insulator Material | Polyester |
| Insulator Color | Blue |
| Flammability Rating | UL94 V-0 |
| Contact Material | Copper alloy |
| Contact Plating | Gold flash 0.76µm Au (min) 1.27µm Au (min) |

ELECTRICAL

| | | |
|--------------------------------------|-----------------|--------------------------|
| Working Voltage (rms) | 100 V to 1000 V | |
| Initial Contact Resistance | Power | 0.2 mΩ* ¹ |
| | Signal | 5 mΩ |
| Contact Current Rating* ² | Power | Up to 100A* ¹ |
| | Signal | 3A* ³ |

*¹ Value established using high conductivity alloy
*² See page 9-10 for temperature rise curves
*³ Hyperboloid contacts 0.60 [0.0236] rated to 4A

MECHANICAL

| | |
|-----------------------------|----------------------------|
| Contact Style | Fixed Removable |
| Female Contact Design | Open entry Closed entry |
| Mating Cycles* ¹ | Up to 1000 |

*¹ Hyperboloid contacts up to 100,000

ENVIRONMENTAL

| | |
|-----------------------|--------------|
| Operating Temperature | -55 to 125°C |
|-----------------------|--------------|

To download detailed product information, visit www.connectpositronic.com/Scorpion/ProductSpecs

OVERALL LENGTH (OAL)

HOW TO CALCULATE OAL

Overall Length (OAL) of a connector is the sum of all the modules' length. Refer to example below for OAL maximum calculation. See page 6-8 for individual module dimensions.

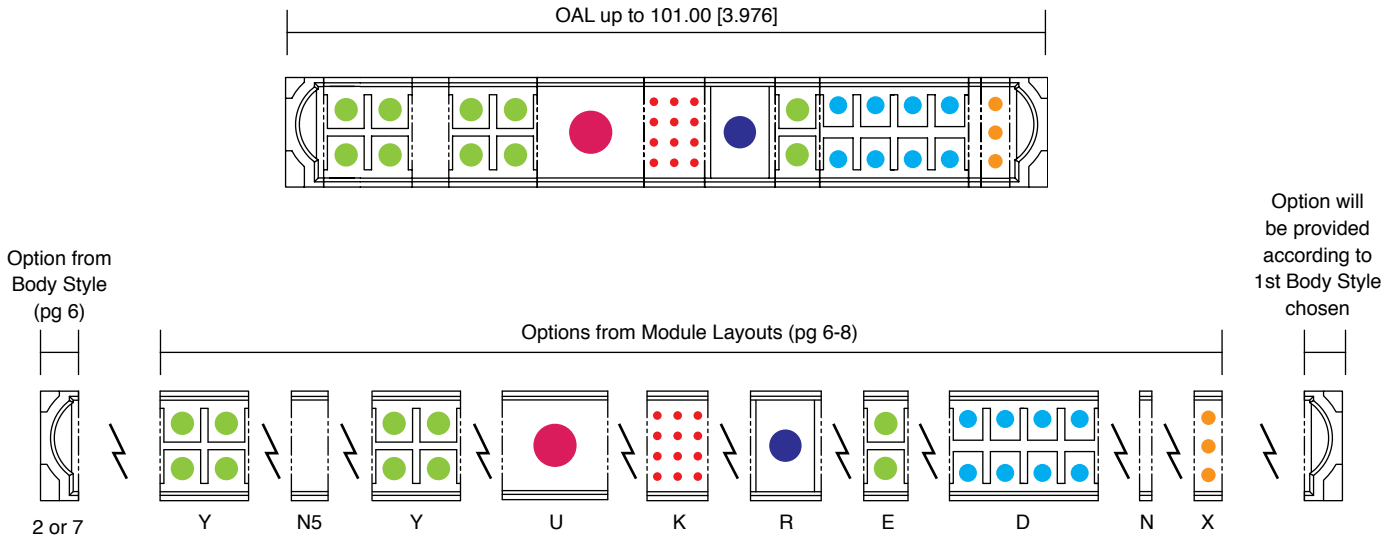

- A Scorpion part number can be a maximum of 30 characters. If the connector configuration exceeds this number, please contact Technical Sales for a special part number for your unique requirement.
- Pinout sequence may not be continuous. Contact Technical Sales for more information.
- Contact Technical Sales for connector length exceeding 101.00 [3.976].
- For connectors offering both fixed solder and crimp contacts, contact Technical Sales.
- Alignment bar is only available for size 16, size 18, size 22, and hyperboloid Ø0.60 [0.0236] right angle contacts.
- PosiBand contacts available for size 12, 16, 18 and 22.
- If there are more than 36 signal pins in one connector, customer will need to take note of the tolerances and alignment issues.



PICMG® logo is a registered trademark of the PCI Industrial Computers Manufacturers Group.

Positronic is proud to participate in PICMG 3.8. The Scorpion series was chosen as the PICMG 3.8 power connector.

CREATE A PART

Mating connector part numbers will have the same letters in the same order. Female connector modules are placed right to left; Male modules are placed left to right when viewed from their mating faces.

| | | | | | |
|--|-----------|----------|-----------|----------|----------|
| | SP | 1 | UU | 1 | M |
|--|-----------|----------|-----------|----------|----------|

Series

- **SP** Scorpion

Body Style *For more information, refer to page 6*

- **Skip this step, if no end modules are required** *1

Blind Mating

- 1 Blind mating, 3.80 [0.150] misalignment
- 2 Blind mating, 2.00 [0.079] misalignment
- 7 Blind mating, 2.00 [0.079] misalignment (use for code 0, BS or N in Mounting Options step)
- 8 Extreme blind mating, up to 3.90 [0.154] misalignment, up to 5° angular misalignment

Latching System

- 3 Locking latch, use with female free cable to male cable
- 4 Locking latch, use with male free cable to female panel mount (wire or PCB)
- 5 Locking latch, use with female free cable to male panel mount (wire or PCB)

Jackscrews

- 6 For use with jackscrew system

*1 If using a backshell on this connector, you must choose N5 in Layout step as first and last modules and skip the Body Style step. Consult Technical Sales for backshell availability for connector without end modules.

Layout *For more information, refer to pages 7-8*

- **One or more modules can be selected in this section to create desired contact layout**

| | |
|---|---|
| <p>Contact Module</p> <ul style="list-style-type: none"> U (1) #4 contact R (1) #8 contact S (2) #8 contacts E (2) #12 contacts Y (4) #12 contacts A (1) #16 contacts B (2) #16 contacts C (4) #16 contacts D (8) #16 contacts X (3) #18 contacts Z (6) #18 contacts H (4) #22 contacts J (8) #22 contacts K (12) #22 contacts T (24) #22 contacts | <p>Hyperboloid</p> <ul style="list-style-type: none"> V (10) Hyperboloid Ø0.60 [0.0236]*1 W (20) Hyperboloid Ø0.60 [0.0236]*1 <p>Keying</p> <ul style="list-style-type: none"> 0 Keying module <p>Blank module</p> <ul style="list-style-type: none"> N Spacer/blank N2 Spacer/blank N3 Spacer/blank N4 Spacer/blank N5 Spacer/blank*2 <p>*1 Unique high density contact design with machined pin diameter Ø0.60 [0.0236], for straight and right angle (90°) PCB mount only. Contact Technical Sales for availability of crimp terminal.</p> <p>*2 For a backshell application, use code N5 next to each body style module.</p> |
|---|---|

Termination *For more information, refer to page 8*

- 1 Wire, order contacts separately*1
- 3 Straight solder
- 38 Straight solder, high conductivity power contacts
- 93 Straight press-fit, for use with PCB not thinner than 2.29 [0.090]*2
- 938 Straight press-fit, for use with PCB not thinner than 2.29 [0.090], high conductivity power contacts*2
- 4 Right angle solder
- 48 Right angle solder, high conductivity power contacts

*1 To order contacts separately, see pages 11-13 for contact part numbers.

*2 For contacts size 8, 12, 16, 18 and 22 only. Contact Technical Sales for press-fit tooling part number.

Contact Gender

- **M** Male pin
- F** Female socket, open and closed entry signal contacts
- S** Female socket, PosiBand closed entry signal contacts

CREATE A PART



BODY STYLE

For the sake of brevity, only the left side of the end module face view is shown.

Scale 1:1

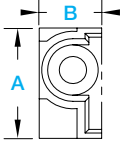
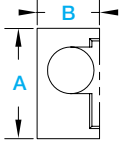
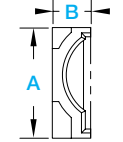
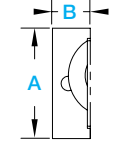
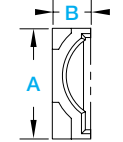
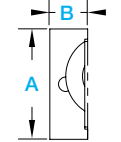
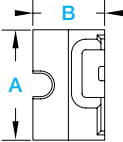
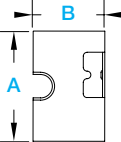
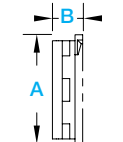
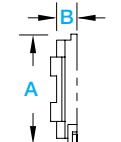
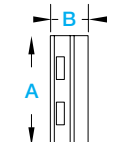
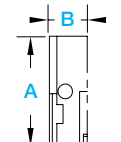
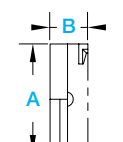
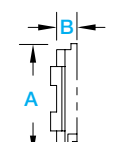
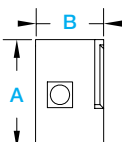
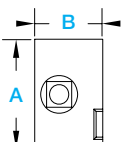
| MALE | FEMALE | CODE | GENDER | A | B | FEATURE |
|---|---|------|--------|---------------|----------------|-----------------|
|  |  | 1 | Male | 14.60 [0.575] | 8.26 [0.325]*1 | Blind mating |
| | | | Female | 14.60 [0.575] | 8.26 [0.325]*1 | Blind mating |
|  |  | 2 | Male | 14.60 [0.575] | 5.00 [0.197]*1 | Blind mating |
| | | | Female | 14.60 [0.575] | 5.00 [0.197]*1 | Blind mating |
|  |  | 7 | Male | 14.60 [0.575] | 4.50 [0.177]*1 | Blind mating |
| | | | Female | 14.60 [0.575] | 4.50 [0.177]*1 | Blind mating |
|  |  | 8 | Male | 14.60 [0.575] | 9.50 [0.374]*1 | Blind mating |
| | | | Female | 14.60 [0.575] | 9.50 [0.374]*1 | Blind mating |
|  |  | 3 | Male | 14.60 [0.575] | 4.00 [0.157]*1 | Latching system |
| | | | Female | 14.60 [0.575] | 2.80 [0.110]*1 | Latching system |
|  |  | 4 | Male | 14.60 [0.575] | 4.76 [0.157] | Latching system |
| | | | Female | 14.60 [0.575] | 5.00 [0.197]*1 | Latching system |
|  |  | 5 | Male | 14.60 [0.575] | 5.00 [0.197]*1 | Latching system |
| | | | Female | 14.60 [0.575] | 2.80 [0.110]*1 | Latching system |
|  |  | 6 | Male | 14.60 [0.575] | 9.20 [0.362]*1 | Jackscrew |
| | | | Female | 14.60 [0.575] | 9.20 [0.362]*1 | Jackscrew |

Images below are shown for reference only, not shown at 1:1 scale.

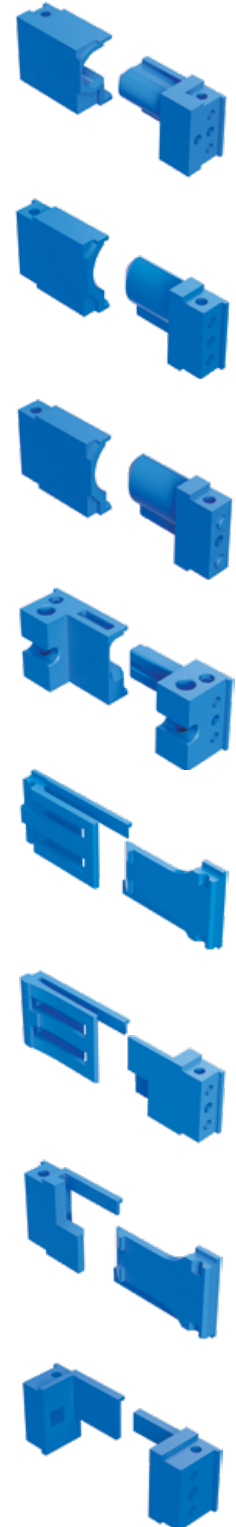

*1 Double dimension for OAL. Dimension shown is only for one module, but connector will be provided with two modules, one left and one right.

MODULE LAYOUTS*1

*1 All modules shown are male modules. Contact Technical Sales for availability of other modules.

Scale 1:1

| CONTACT MODULES | CODE | SIZE | A | B |
|-----------------|------|------|---------------|---------------|
| | U | #4 | 14.60 [0.575] | 14.20 [0.559] |
| | R | #8 | 14.60 [0.575] | 9.40 [0.370] |
| | S | #8 | 14.60 [0.575] | 18.80 [0.740] |
| | E | #12 | 14.60 [0.575] | 5.90 [0.232] |
| | Y | #12 | 14.60 [0.575] | 11.80 [0.465] |
| | A | #16 | 14.60 [0.575] | 4.96 [0.195] |
| | B | #16 | 14.60 [0.575] | 4.96 [0.195] |
| | C | #16 | 14.60 [0.575] | 9.92 [0.391] |
| | D | #16 | 14.60 [0.575] | 19.84 [0.781] |

| CONTACT MODULES | CODE | SIZE | A | B |
|-----------------|------|------|---------------|---------------|
| | X | #18 | 14.60 [0.575] | 3.80 [0.150] |
| | Z | #18 | 14.60 [0.575] | 7.60 [0.299] |
| | H | #22 | 14.60 [0.575] | 2.70 [0.106] |
| | J | #22 | 14.60 [0.575] | 5.40 [0.213] |
| | K | #22 | 14.60 [0.575] | 8.10 [0.319] |
| | T | #22 | 14.60 [0.575] | 16.20 [0.638] |

| Contact Size Chart | | | | | | |
|--------------------|----|-----|-----|-----|-----|--------|
| #4 | #8 | #12 | #16 | #18 | #22 | 0.60mm |
| | | | | | | |





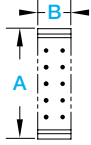
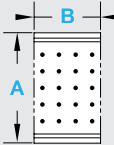

All Positronic products utilize solid, machined contacts.

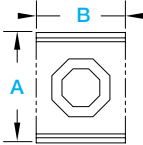
MODULE LAYOUTS



Scale 1:1

| HYPERBOLOID MODULES 0.60 [0.0236] | CODE | A | B |
|---|------|---------------|--------------|
|  | V | 14.60 [0.575] | 4.40 [0.173] |
|  | W | 14.60 [0.575] | 8.80 [0.346] |

| KEYING MODULE | CODE | A | B |
|---|------|---------------|---------------|
|  | O | 14.60 [0.575] | 11.80 [0.465] |

| Contact Size Chart | | | | | | |
|---|---|---|---|---|---|---|
| #4 | #8 | #12 | #16 | #18 | #22 | 0.60mm |
|  |  |  |  |  |  |  |

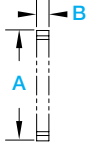
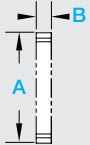
All Positronic products utilize solid, machined contacts.

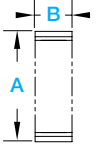
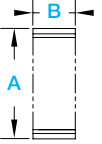
| BLANK MODULES | CODE | A | B |
|--|------|---------------|--------------|
|  | N | 14.60 [0.575] | 1.62 [0.064] |
|  | N2 | 14.60 [0.575] | 2.00 [0.079] |
|  | N3 | 14.60 [0.575] | 3.46 [0.136] |
|  | N4 | 14.60 [0.575] | 4.88 [0.192] |
|  | N5 | 14.60 [0.575] | 5.60 [0.220] |

CONTACT TERMINATIONS DIMENSIONS

For the sake of brevity, only the Male single row size 8 contact modules are shown. Dimension shown apply for all contacts regardless of size and gender.

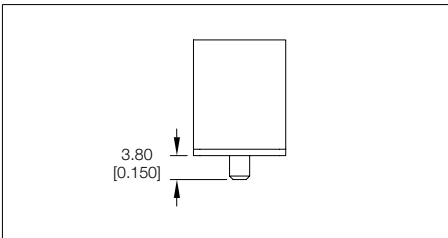
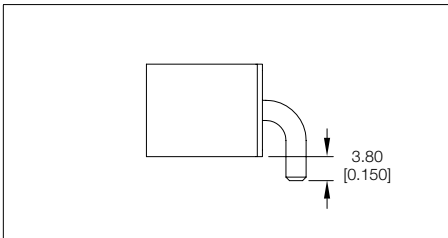
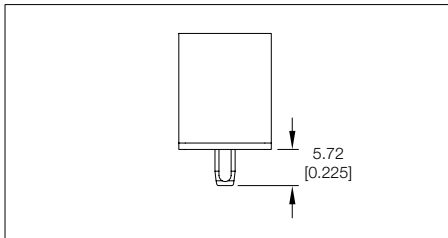
| STRAIGHT SOLDER | RIGHT ANGLE SOLDER | PRESS-FIT*1 |
|---|--|---|
|  |  |  |

*1 For information of suggested straight mount PCB hole sizes, please visit our website to [download SK 6370](#).

To download detailed product information, visit www.connectpositronic.com/Scorpion/ProductSpecs

MATING DIMENSIONS

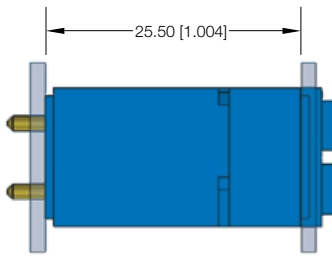

Straight PCB mount (Male) to Panel Mount Crimp (Female)

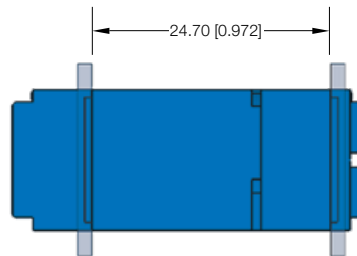

Panel Mount Crimp (Male) to Panel Mount Crimp (Female)

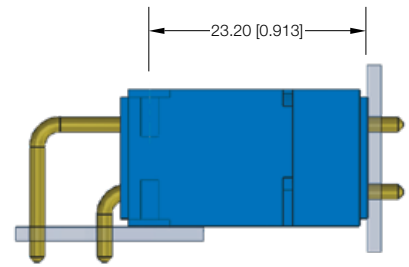

Right Angle Board Mount (Male) to Straight PCB Mount (Female)

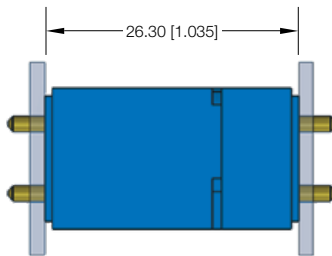

Straight PCB Mount (Male) to Straight PCB Mount (Female)

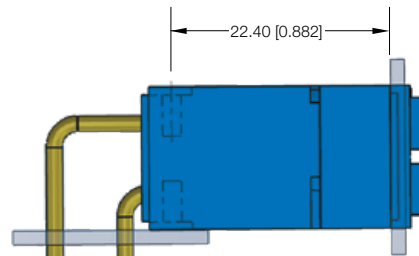

Right Angle Board Mount (Male) to Panel Mount Crimp (Female)

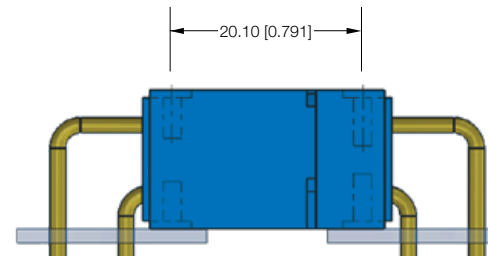

Right Angle Board Mount (Male) to Right Angle Board Mount (Female)

TEMPERATURE RISE CURVES

Tested per IEC Publication 60512-3, Test 5a

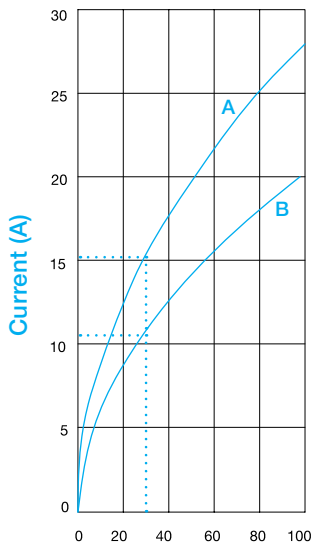

Size 18 Temperature rise (°C)

- A** Developed with (6) #18 high conductivity contacts seated in code Z modules.
- B** Developed with (6) #18 standard conductivity contacts seated in code Z modules.

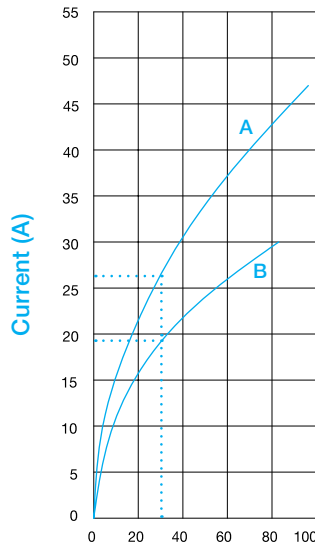

Size 16 Temperature rise (°C)

- A** Developed with (2) #16 high conductivity contacts seated in code B modules.
- B** Developed with (2) #16 standard conductivity contacts seated in code B modules.

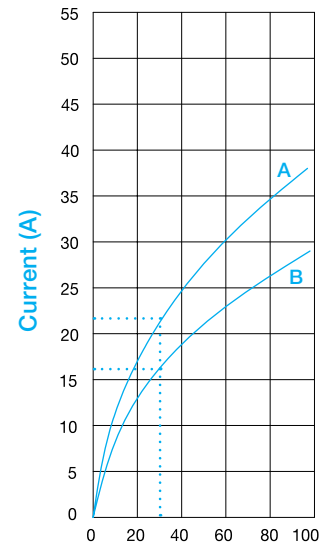

Size 16 Temperature rise (°C)

- A** Developed with (8) #16 high conductivity contacts seated in code CC modules.
- B** Developed with (8) #16 standard conductivity contacts seated in code CC modules.

To download detailed product information, visit www.connectpositronic.com/Scorpion/ProductSpecs

TEMPERATURE RISE CURVES

Tested per IEC Publication 60512-3, Test 5a

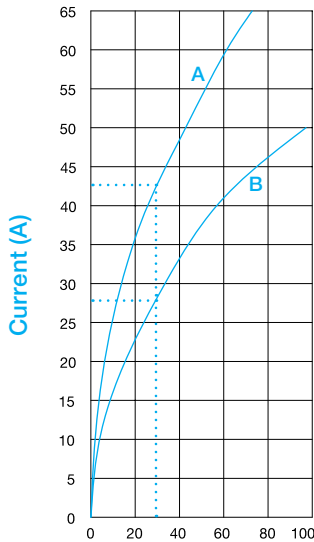

Size 12 Temperature rise (°C)

- A** Developed with (2) #12 high conductivity contacts seated in code E modules.
- B** Developed with (2) #12 standard conductivity contacts seated in code E modules.

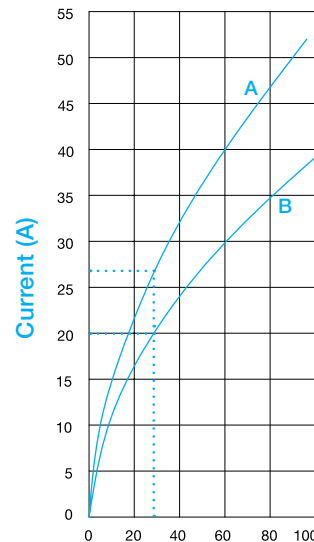

Size 12 Temperature rise (°C)

- A** Developed with (10) #12 high conductivity contacts seated in code EYY modules.
- B** Developed with (10) #12 standard conductivity contacts seated in code EYY modules.

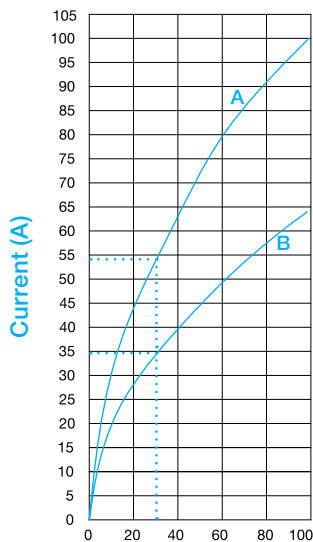

Size 8 Temperature rise (°C)

- A** Developed with (2) #8 high conductivity contacts seated in code RR modules.
- B** Developed with (2) #8 standard conductivity contacts seated in code RR modules.

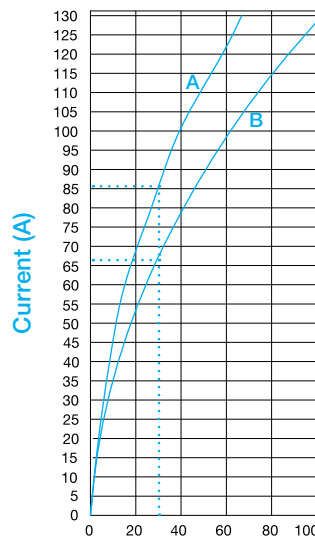

Size 4 Temperature rise (°C)

- A** Developed with (2) #4 high conductivity contacts seated in code UU modules.
- B** Developed with (2) #4 standard conductivity contacts seated in code UU modules.

To download detailed product information, visit www.connectpositronic.com/Scorpion/ProductSpecs

CONTACTS*1

SC Standard conductivity contacts
HC High conductivity contacts

*1 Contact Technical Sales for more details on additional contact sizes, material, finishes, and termination styles.

REMOVABLE CRIMP CONTACTS

| PART NUMBER | | Size | Gender | Female Contact Style | Stranded AWG [mm ²] | Sequential Mate |
|----------------|----|------|--------|----------------------|---------------------------------|-----------------|
| FC0404N2 | SC | #4 | Female | Closed entry | #4 [25.0] | |
| FC0404N2S | HC | #4 | Female | Closed entry | #4 [25.0] | |
| MC0404N | SC | #4 | Male | n/a | #4 [25.0] | |
| MC0404NS | HC | #4 | Male | n/a | #4 [25.0] | |
| FC4008DS | HC | #8 | Female | Closed entry | #8 [10.0] | |
| FC4008DS-PA781 | HC | #8 | Female | Closed entry | #8 [10.0] | First |
| FC4010D | SC | #8 | Female | Closed entry | #10 [5.3] | |
| FC4010D-PA781 | SC | #8 | Female | Closed entry | #10 [5.3] | First |
| FC4010DS | HC | #8 | Female | Closed entry | #10 [5.3] | |
| FC4010DS-PA781 | HC | #8 | Female | Closed entry | #10 [5.3] | First |
| FC4012D | SC | #8 | Female | Closed entry | #12 [4.0] | |
| FC4012D-PA781 | SC | #8 | Female | Closed entry | #12 [4.0] | First |
| FC4012DS | HC | #8 | Female | Closed entry | #12 [4.0] | |
| FC4012DS-PA781 | HC | #8 | Female | Closed entry | #12 [4.0] | First |
| FC4016D | SC | #8 | Female | Closed entry | #16 [1.5] | |
| FC4016D-PA781 | SC | #8 | Female | Closed entry | #16 [1.5] | First |
| FC4016DS | HC | #8 | Female | Closed entry | #16 [1.5] | |
| FC4016DS-PA781 | HC | #8 | Female | Closed entry | #16 [1.5] | First |
| MC4008DS | HC | #8 | Male | n/a | #8 [10.0] | |
| MC4008DS-PA781 | HC | #8 | Male | n/a | #8 [10.0] | First |
| MC4010D | SC | #8 | Male | n/a | #10 [5.3] | |
| MC4010D-PA781 | SC | #8 | Male | n/a | #10 [5.3] | First |
| MC4010DS | HC | #8 | Male | n/a | #10 [5.3] | |
| MC4010DS-PA781 | HC | #8 | Male | n/a | #10 [5.3] | First |
| MC4012D | SC | #8 | Male | n/a | #12 [4.0] | |
| MC4012D-PA781 | SC | #8 | Male | n/a | #12 [4.0] | First |
| MC4012DS | HC | #8 | Male | n/a | #12 [4.0] | |
| MC4012DS-PA781 | HC | #8 | Male | n/a | #12 [4.0] | First |
| MC4016D | SC | #8 | Male | n/a | #16 [1.5] | |
| MC4016D-PA781 | SC | #8 | Male | n/a | #16 [1.5] | First |
| MC4016DS | HC | #8 | Male | n/a | #16 [1.5] | |
| MC4016DS-PA781 | HC | #8 | Male | n/a | #16 [1.5] | First |
| FC1210P2 | SC | #12 | Female | Closed entry | #10 [6.0] | |
| FC1210P2S | HC | #12 | Female | Closed entry | #10 [6.0] | |
| FC1212P2 | SC | #12 | Female | Closed entry | #12 [4.0] | |
| FC1212P2S | HC | #12 | Female | Closed entry | #12 [4.0] | |
| MC1210N-PA563 | SC | #12 | Male | n/a | #10 [6.0] | First |
| MC1210NS-PA563 | HC | #12 | Male | n/a | #10 [6.0] | First |
| MC1210N | SC | #12 | Male | n/a | #10 [6.0] | |
| MC1210NS | HC | #12 | Male | n/a | #10 [6.0] | |
| MC1212N-PA563 | SC | #12 | Male | n/a | #12 [4.0] | First |
| MC1212NS-PA563 | HC | #12 | Male | n/a | #12 [4.0] | First |
| MC1212N | SC | #12 | Male | n/a | #12 [4.0] | |
| MC1212NS | HC | #12 | Male | n/a | #12 [4.0] | |

CONTACTS*1

| | |
|----|--------------------------------|
| SC | Standard conductivity contacts |
| HC | High conductivity contacts |

*1 Contact Technical Sales for more details on additional contact sizes, material, finishes, and termination styles.

REMOVABLE CRIMP CONTACTS

| PART NUMBER | | Size | Gender | Female Contact Style | Stranded AWG [mm ²] | Sequential Mate |
|------------------|----|------|--------|----------------------|---------------------------------|-----------------|
| FC112P2-PA907 | SC | #16 | Female | Closed entry | #12 [4.0] | |
| FC112P2S-PA907 | HC | #16 | Female | Closed entry | #12 [4.0] | |
| FC114P2-PA907 | SC | #16 | Female | Closed entry | #14-16 [2.5-1.5] | |
| FC116P2-PA907 | SC | #16 | Female | Closed entry | #16-18-20 [1.5-1.0-0.5] | |
| FC120P2-PA907 | SC | #16 | Female | Closed entry | #20-22-24 [0.5-0.3-0.25] | |
| MC112N-133.5 | SC | #16 | Male | n/a | #12 [4.0] | First |
| MC112NS-133.5 | HC | #16 | Male | n/a | #12 [4.0] | First |
| MC112N | SC | #16 | Male | n/a | #12 [4.0] | |
| MC112NS | HC | #16 | Male | n/a | #12 [4.0] | |
| MC114N-133.5 | SC | #16 | Male | n/a | #14-16 [2.5-1.5] | First |
| MC114N | SC | #16 | Male | n/a | #14-16 [2.5-1.5] | |
| MC116N-133.5 | SC | #16 | Male | n/a | #16-18-20 [1.5-1.0-0.5] | First |
| MC116N | SC | #16 | Male | n/a | #16-18-20 [1.5-1.0-0.5] | |
| MC120N-133.5 | SC | #16 | Male | n/a | #20-22-24 [0.5-0.3-0.25] | First |
| MC120N | SC | #16 | Male | n/a | #20-22-24 [0.5-0.3-0.25] | |
| FC1816P2 | SC | #18 | Female | Closed entry | #16-18 [1.5-1.0] | |
| FC1816P2S | HC | #18 | Female | Closed entry | #16-18 [1.5-1.0] | |
| FC1820P2 | SC | #18 | Female | Closed entry | #20 [0.5] | |
| FC1820P2S | HC | #18 | Female | C\$5 | #20 [0.5] | |
| MC1816N-PA561 | SC | #18 | Male | n/a | #16-18 [1.5-1.0] | First |
| MC1816NS-PA561 | HC | #18 | Male | n/a | #16-18 [1.5-1.0] | First |
| MC1816N | SC | #18 | Male | n/a | #16-18 [1.5-1.0] | |
| MC1816NS | HC | #18 | Male | n/a | #16-18 [1.5-1.0] | |
| MC1820N-PA561 | SC | #18 | Male | n/a | #20 [0.5] | First |
| MC1820NS-PA561 | HC | #18 | Male | n/a | #20 [0.5] | First |
| MC1820N | SC | #18 | Male | n/a | #20 [0.5] | |
| MC1820NS | HC | #18 | Male | n/a | #20 [0.5] | |
| FC422P9 | SC | #22 | Female | Closed entry | #22-26 [0.3-0.12] | |
| MC422N9 | SC | #22 | Male | n/a | #22-26 [0.3-0.12] | |
| MC422N9-PA1116*1 | SC | #22 | Male | n/a | #22-26 [0.3-0.12] | |

*1 For use with alignment insert.

NON-REMOVABLE CRIMP CONTACTS

| PART NUMBER | | Size | Gender | Female Contact Style | Stranded AWG [mm ²] |
|--------------|----|------|--------|----------------------|---------------------------------|
| FC422T-PA908 | SC | #22 | Female | Closed entry | #22-26 [0.3-0.12] |
| MC422T-PA908 | SC | #22 | Male | n/a | #22-26 [0.3-0.12] |

NON-REMOVABLE HYPERBOLOID CRIMP CONTACTS

| PART NUMBER | | Size | Gender | Female Contact Style | Stranded AWG [mm ²] |
|-------------|----|---------------|--------|----------------------|---------------------------------|
| FC3124T | SC | 0.60 [0.0236] | Female | Closed entry | #24-28 [0.25-0.08] |
| MC3124T | SC | 0.60 [0.0236] | Male | n/a | #24-28 [0.25-0.08] |

CONTACTS*1

*1 Contact Technical Sales for more details on additional contact sizes, material, finishes, and termination styles.

| | |
|----|--------------------------------|
| SC | Standard conductivity contacts |
| HC | High conductivity contacts |

REMOVABLE CONTACTS, BUS BAR INTERNAL THREADS

| PART NUMBER | | Size | Gender | Female Contact Style | Thread |
|-------------|----|------|--------|----------------------|--------------|
| SPFIT04M | SC | #4 | Female | Closed entry | M5 x 0.8 |
| SPFIT04MS | HC | #4 | Female | Closed entry | M5 x 0.8 |
| SPFIT04S | SC | #4 | Female | Closed entry | 10-24 UNC 2B |
| SPFIT04SS | HC | #4 | Female | Closed entry | 10-24 UNC 2B |
| SPMIT04M | SC | #4 | Male | n/a | M5 x 0.8 |
| SPMIT04MS | HC | #4 | Male | n/a | M5 x 0.8 |
| SPMIT04S | SC | #4 | Male | n/a | 10-24 UNC 2B |
| SPMIT04SS | HC | #4 | Male | n/a | 10-24 UNC 2B |

Scale 1:1

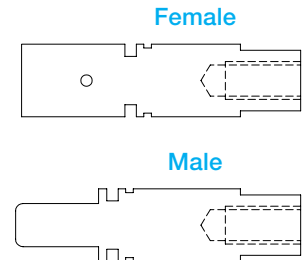

REMOVABLE CONTACTS, BUS BAR EXTERNAL THREADS

| PART NUMBER | | Size | Gender | Female Contact Style | Thread |
|-------------|----|------|--------|----------------------|--------------|
| SPFET04M | SC | #4 | Female | Closed entry | M5 x 0.8 |
| SPFET04MS | HC | #4 | Female | Closed entry | M5 x 0.8 |
| SPFET04S | SC | #4 | Female | Closed entry | 10-24 UNC 2A |
| SPFET04SS | HC | #4 | Female | Closed entry | 10-24 UNC 2A |
| SPMET04M | SC | #4 | Male | n/a | M5 x 0.8 |
| SPMET04MS | HC | #4 | Male | n/a | M5 x 0.8 |
| SPMET04S | SC | #4 | Male | n/a | 10-24 UNC 2A |
| SPMET04SS | HC | #4 | Male | n/a | 10-24 UNC 2A |

Scale 1:1

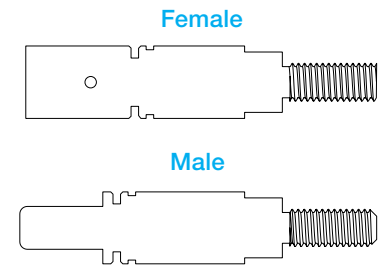

REMOVABLE CONTACTS, RIGHT ANGLE THREAD FOR RING TERMINAL

| PART NUMBER | | Size | Gender | Female Contact Style | Thread | Stranded AWG [mm ²] |
|-------------|----|------|--------|----------------------|--------------|---------------------------------|
| SPFRA04M | SC | #4 | Female | Closed entry | M5 x 0.8 | #10 [5.3] |
| SPFRA04MS | HC | #4 | Female | Closed entry | M5 x 0.8 | #10 [5.3] |
| SPFRA04S | SC | #4 | Female | Closed entry | 10-24 UNC 2B | #10 [5.3] |
| SPFRA04SS | HC | #4 | Female | Closed entry | 10-24 UNC 2B | #10 [5.3] |
| SPMRA04M | SC | #4 | Male | n/a | M5 x 0.8 | #10 [5.3] |
| SPMRA04MS | HC | #4 | Male | n/a | M5 x 0.8 | #10 [5.3] |
| SPMRA04S | SC | #4 | Male | n/a | 10-24 UNC 2B | #10 [5.3] |
| SPMRA04SS | HC | #4 | Male | n/a | 10-24 UNC 2B | #10 [5.3] |

Scale 1:1

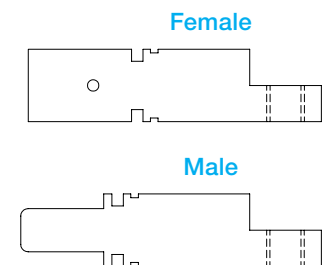

ACCESSORIES

PCB MOUNT

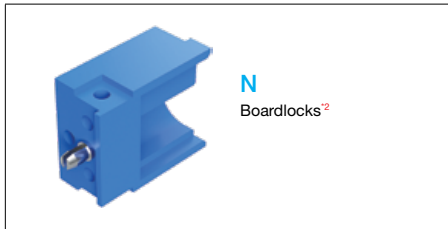
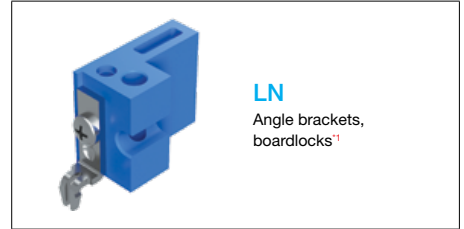
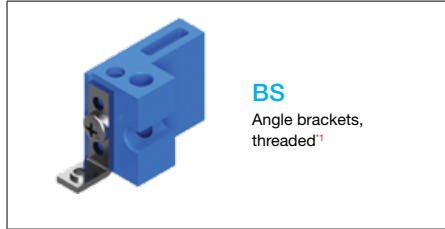
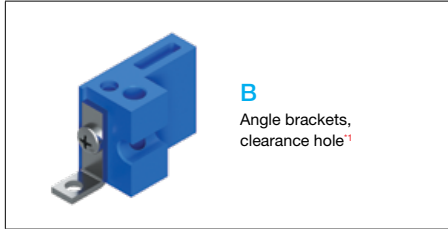

^{*1} For use with right angle PCB mount using code 4 or 48 in Termination step.
^{*2} For use with straight and right angle PCB mount using code 3, 38, 4 or 48 in Termination step.

| CODE | MATERIALS |
|-----------|-----------------------------|
| B, BS, LN | Brass with tin plate |
| N | Copper alloy with tin plate |

PANEL MOUNT

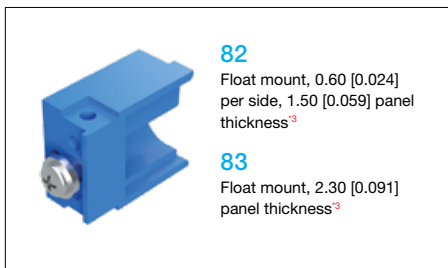
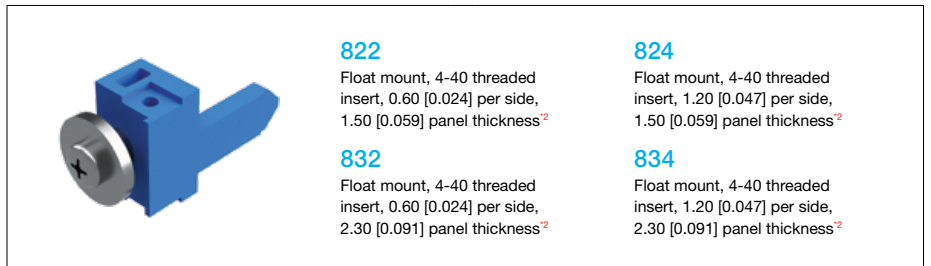
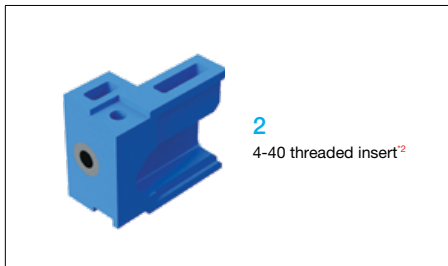
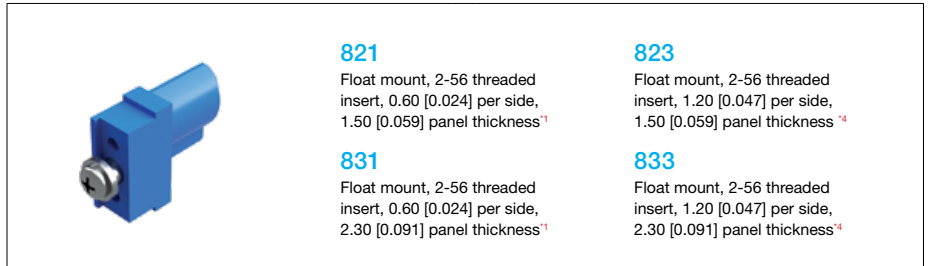
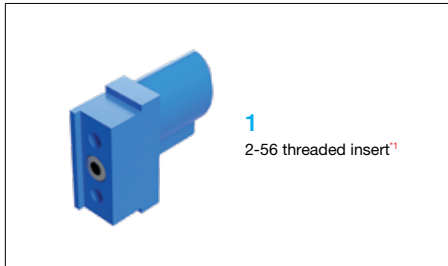

^{*1} For use with code 1 or 2 in Body Style step.
^{*2} For use with code 8 in Body Style step.
^{*3} For use with code 1, 2, 4 or 5 in Body Style step, contact Technical Sales for more floating options.
^{*4} For use with code 1 in Body Style step, contact Technical Sales for more floating options.

| CODE | MATERIALS |
|--|-----------------------|
| 1, 2 | Brass |
| 82, 83, 821, 822, 823, 824, 831, 832, 833, 834 | Steel with zinc plate |

To download detailed product information, visit www.connectpositronic.com/Scorpion/ProductSpecs

ACCESSORIES

JACKPOST/JACKSCREW SYSTEMS

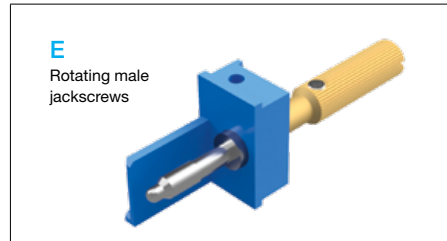
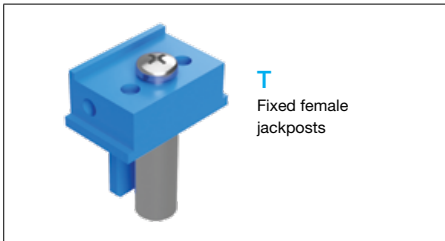
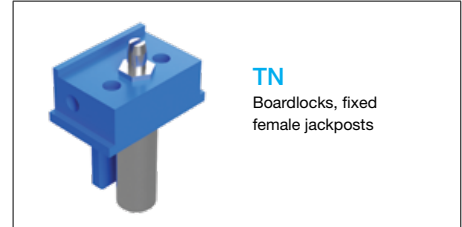
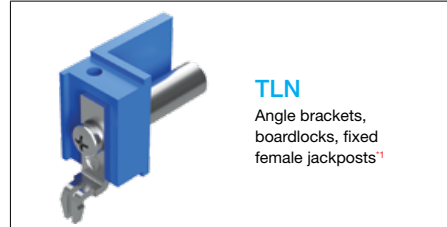
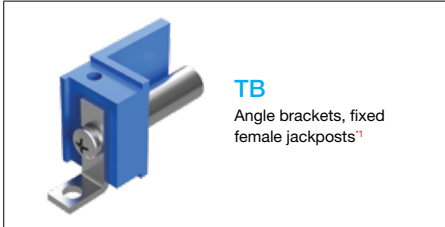

^{*1} For use with right angle PCB mount using code 4 or 48 in Termination step.

| MATERIALS | |
|-----------------------------------|-----------------------------|
| Screw | Steel with zinc plate |
| Jackpost, hex nut and lock washer | Stainless steel, passivated |
| Knobs | Aluminum, yellow anodized |

BACKSHELL

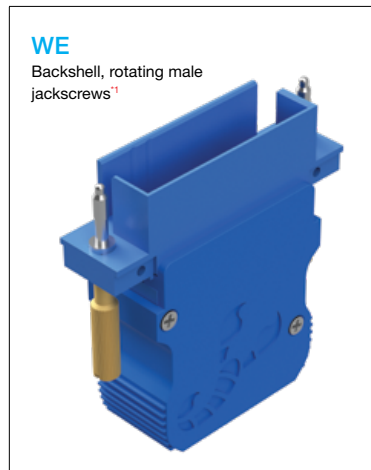
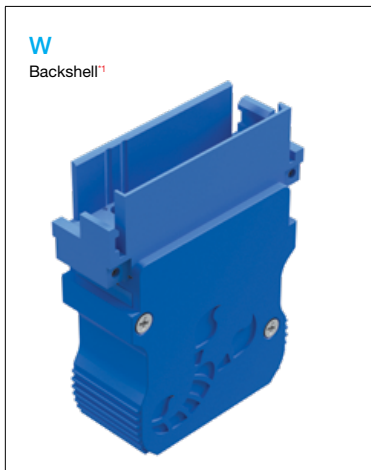

^{*1} For use with two N5 spacer modules in Layout step, one spacer will be needed on each end of connector.

| MATERIALS | |
|--------------------|--|
| Backshell | Glass-filled polyester, UL94 V-0, blue |
| Screws | Steel, zinc plate with chromate seal |
| Cable clamp | Steel with nickel plate |
| Cable clamp screws | Brass, zinc plate with chromate seal |

VENTING FEATURES



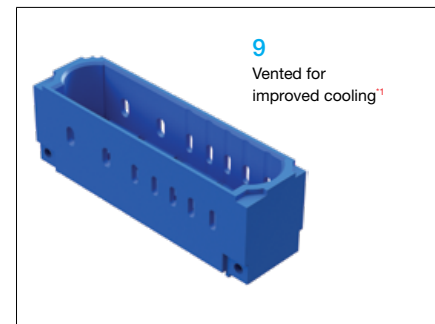
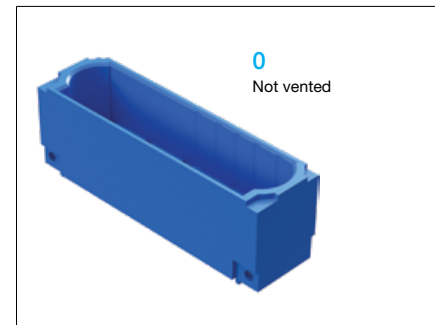

Venting feature is a outlet hole enabling air cooling onto a power contact. In compliance with UL 1977, section 10.2 accessibility of live parts.



^{*1} Not for use with module A in Layout step or with signal contacts.

To download detailed product information, visit www.connectpositronic.com/Scorpion/ProductSpecs

See connectpositronic.com/Scorpion for all other Scorpion-related information including:

- ✓ **Footprints** 
- ✓ **Tooling** 
- ✓ **Product updates** 
- ✓ **Detailed dimensions** 
- ✓ **2D/3D drawings** 

All dimensional tolerances are ± 0.38 [0.015], unless otherwise specified: ± 0.03 mm [0.001 inches] for male contact mating diameters; ± 0.08 mm [0.003 inches] for contact termination diameters; ± 0.13 mm [0.005 inches] for all other diameters; ± 0.38 mm [0.015 inches] for all other dimensions. Dimensions are in millimeter [inches]. All dimensions are subject to change. Product pictures may not be identical in appearance to actual production parts.

Information in this catalog is proprietary to Positronic and its subsidiaries. Positronic believes the data contained herein to be reliable. Since the technical information is given free of charge, the user employs such information at his own discretion and risk. Positronic assumes no responsibility for results obtained or damages incurred from use of such information in whole or in part.

The following trademarks are owned by Positronic Industries, Inc.: Positronic Industries, Inc.®, Positronic®, Connector Excellence®, P+ logo®, PosiBand®, PosiShop®, Optik-D™, and The Science of Certainty®. The color blue as it appears on various connectors is a trademark of Positronic Industries, Inc., Registered in U.S. Patent and Trademark Office.

Products described within this catalog may be protected by one or more of the following US patents:

#4,900,261 #5,255,580 #5,329,697 #6,260,268
#6,835,079 #7,115,002 #8,944,697 #9,304,263

Patented in Canada, 1992 Other patents pending

Federal Supply Code for Manufacturers

Positronic Industries: 28198
Positronic Industries SAS: FA7Y0
Positronic Asia PTE LTD: QB952

Positronic | Americas

423 N Campbell Ave
Springfield MO 65806 USA
+1 800 641 4054
info@connectpositronic.com

Positronic | Europe

46 route d'Engachies
F-32020 Auch Cedex 9 France
+33 5 6263 4491
contact@connectpositronic.com

Positronic | Asia

3014A Ubi Rd 1 #07-01
+65 6842 1419
Singapore 408703
singapore@connectpositronic.com

Sales Offices

Positronic has local sales representation all over the world. For the nearest sales office visit www.connectpositronic.com/sales